

Elektrozubehör

für Kassettenrollosysteme mit
230 Volt - Elektroantrieb

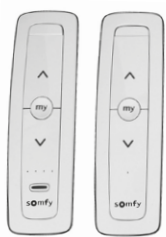

Durach

Sonnenschutz | Blendschutz | Raumakustik

Steuergeräte bei Bedienung über Schalter

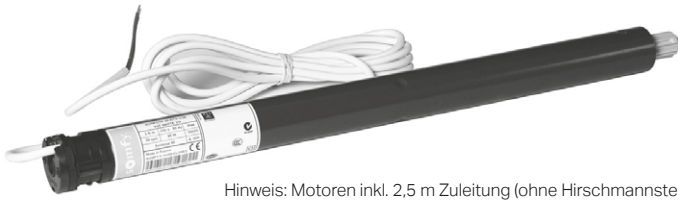

**Standardmotor
Somfy Sonesse 40**
230 Volt Elektroantrieb
Art. Nr. 1352

Hinweis: Motoren inkl. 2,5 m Zuleitung (ohne Hirschmannstecker)



Standardschalter
Inis Uno
Art. Nr. 1325

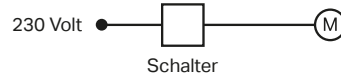

Motorsteuergerät
Smoove Uno IB
Art. Nr. 1319

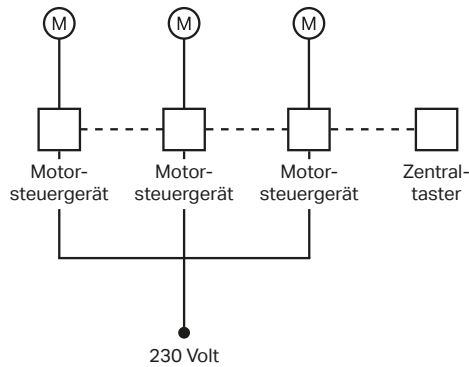

Zentraltaster
Smoove Origin IB
Art. Nr. 1317

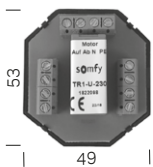

1-fach Trennrelais TR1
Art. Nr. TR1

Höhe: 22 mm

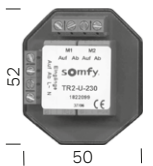
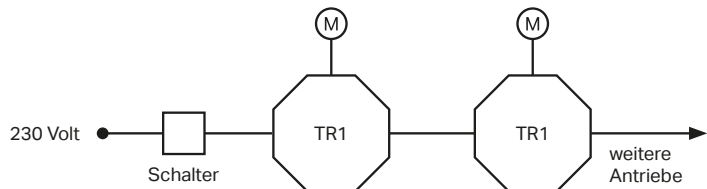

2-fach Trennrelais TR2
Art. Nr. TR2

Höhe: 22 mm

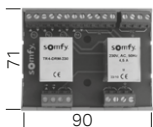
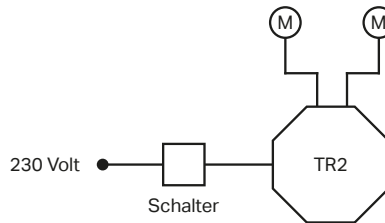

4-fach Trennrelais TR4
Art. Nr. TR4

Höhe: 62 mm

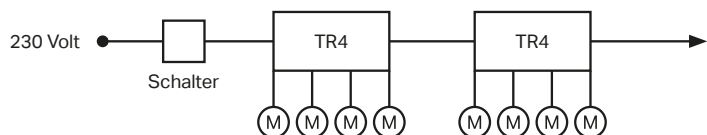

Steuergeräte bei Bedienung über Funk - io (Standard)

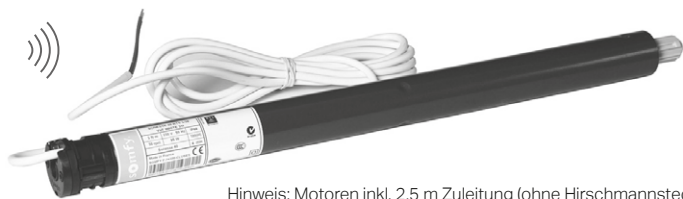

Hinweis: Motoren inkl. 2,5 m Zuleitung (ohne Hirschmannstecker)

io-Funkempfänger (in Motor integriert)

Somfy Sonesse 40 io

Art. Nr. 1365



1-Kanal Funk-Handsender

Situo 1 io Pure II

Art. Nr. 1321

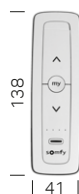

5-Kanal Funk-Handsender

Situo 5 io Pure II

Art. Nr. 1322



1-Kanal Funk-Wandsender

Smooove Origin io

Art. Nr. 1328

Steuergeräte bei Bedienung über Funk - RTS

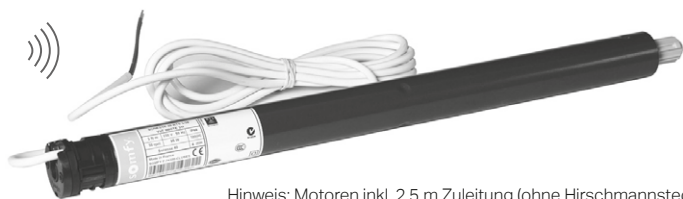

Hinweis: Motoren inkl. 2,5 m Zuleitung (ohne Hirschmannstecker)

Funkempfänger (in Motor integriert)

Somfy Sonesse 40 RTS

Art. Nr. 1350



1-Kanal Funk-Handsender

Situo 1 RTS Pure II

Art. Nr. 1327



5-Kanal Funk-Handsender

Situo 5 RTS Pure II

Art. Nr. 1329



16-Kanal Funk-Handsender

Telis 16 RTS Pure

Art. Nr. 1320



1-Kanal Funk-Wandsender

Smooove Origin RTS

Art. Nr. 1318

Hirschmannstecker und Kabelpeitschen für Sonesse® Motoren



**Hirschmannstecker (zweiteilig)
lose**

Art. Nr. 1360



**Hirschmannstecker (zweiteilig)
motorseitiger Stecker vormontiert**

Art. Nr. 1359



**Hirschmannstecker (STAS 3)
motorseitiger Stecker, vormontiert**

Art. Nr. 1358



**Hirschmannstecker (STAK 3)
bauseitiger Stecker, lose**

Art. Nr. 1357



**Kabelpeitsche (einseitig mit Stecker
STAK 3, einseitig mit losem Kabelende)**

Art. Nr. 1390 500 cm
Art. Nr. 1391 1000 cm
Art. Nr. 1392 2000 cm



Halterung für Hirschmannstecker

Art. Nr. R - 1361 (V2A geschliffen)
Art. Nr. R - 1362 (weiß)



Motorseitig (STAS 3)

Bauseitig (STAK 3)



Abmessungen inkl. Metallbügel (L x B x H): 149 x 29 x 23 mm

Montagevarianten Halterung

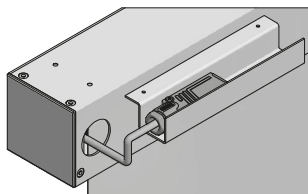

Halterung an Decke montiert

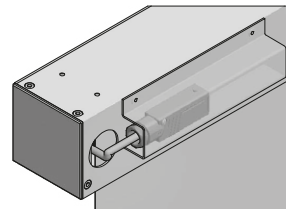

Halterung an Kassette montiert

Steckverbinder EasyFix



**Steckverbinder EasyFix (zweiteilig)
lose**

Art. Nr. 1380



Steckverbinder EasyFix (vormontiert)

Art. Nr. 1379



Motorseitig Verbindungsstück Bauseitig

Abmessungen (L x B x H): 70 x 18 x 18 mm